



PowerBeam® AC GEN2

5 GHz High-Performance
airMAX® ac Bridge

Model: PBE-5AC-Gen2

QUICK START GUIDE

Introduction

Thank you for purchasing the Ubiquiti Networks® PowerBeam® AC Gen 2. This Quick Start Guide is designed to guide you through installation and includes warranty terms.

Package Contents



Dish Reflector



Antenna Feed



Rear Housing



Adjustment
Bracket



Mounting
Bracket



Hex Bolts with
Washers (Qty. 4)



Pole
Clamp



Long Carriage
Bolts (Qty. 2)



Flange Nuts
(Qty. 2)



Gigabit PoE
(24V, 0.5A) with
Mounting Bracket



Power Cord



Quick Start
Guide

TERMS OF USE: Ubiquiti radio devices must be professionally installed. Shielded Ethernet cable and earth grounding must be used as conditions of product warranty. TOUGHcable™ is designed for outdoor installations. It is the professional installer's responsibility to follow local country regulations, including operation within legal frequency channels, output power, and Dynamic Frequency Selection (DFS) requirements.

Installation Requirements

- 13 mm wrench
- Shielded Category 5 (or above) cabling with drain wire should be used for all wired Ethernet connections and should be grounded through the AC ground of the PoE.

We recommend that you protect your networks from harmful outdoor environments and destructive ESD events with industrial-grade, shielded Ethernet cable from Ubiquiti Networks. For more details, visit www.ubnt.com/toughcable

- Surge protection should be used for all outdoor installations. We recommend that you use two Ethernet Surge Protectors, model ETH-SP, one near the PowerBeam and the other at the entry point to the building. The ETH-SP will absorb power surges and safely discharge them into the ground.

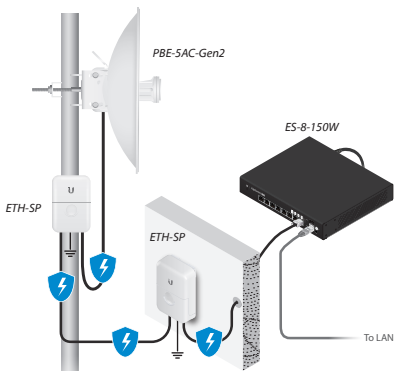

Hardware Overview

Bottom View

InnerFeed[®]
Technology

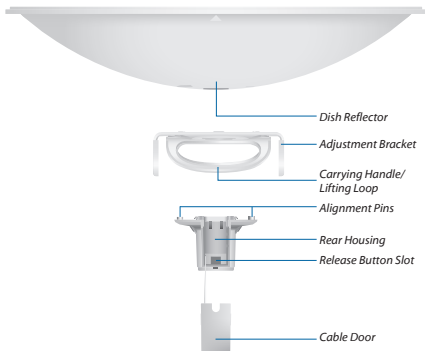
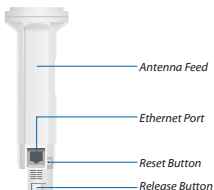



Reset Button To reset to factory defaults, press and hold the *Reset* button for more than 10 seconds while the PowerBeam is powered on. Alternatively, the PowerBeam may be reset remotely via a *Reset* button located on the bottom of the *Gigabit PoE Adapter*.

Release Button After you assemble the PowerBeam, check the *Release* button; it should be fully engaged in the *Release Button Slot* of the *Rear Housing*. This ensures that the *Antenna Feed* is locked into place. If you need to remove the *Antenna Feed*, you must depress the *Release* button first.

LEDs



 **Power** The Power LED will light blue when the device is connected to a power source.

 **Ethernet** The Ethernet LED will light steady blue when an active Ethernet connection is made and flash when there is activity.

 **Signal** In airOS®, you can modify the threshold value for the wireless signal strength LEDs on the *Wireless* tab under *Signal LED Thresholds*. Each LED will light when the wireless signal strength is equal to or greater than the LED's threshold value. The default threshold values for these LEDs are shown below:

-65 dBm -73 dBm -80 dBm -94 dBm



Application Examples

The PowerBeam mounted outdoors with the *Dish Reflector* installed provides directional outdoor coverage (gain is reflector-dependent).

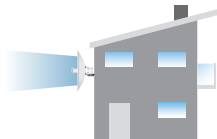

The PowerBeam mounted outdoors without the *Dish Reflector* installed provides outdoor-to-indoor coverage using the 3 dBi *Antenna Feed* only.

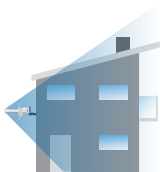

Installation

1. Align and insert the tabs of the *Adjustment Bracket* into the slots of the *Dish Reflector*. Rotate the *Adjustment Bracket* counterclockwise until the alignment holes in the dish and bracket align with each other.

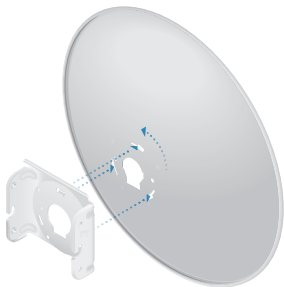

2. Remove the *Antenna Feed* from the *Rear Housing*:
 - a. Push in the sides of the *Cable Door* and detach it from the *Rear Housing*. Keep the *Cable Door* detached.
 - b. Press the *Release Button* and slide the *Rear Housing* off of the *Antenna Feed*.



3. Line up the *Alignment Pins* of the *Rear Housing* with the alignment holes of the *Adjustment Bracket*. Push the *Rear Housing* into the *Adjustment Bracket*.



 **Note:** In high-wind environments, you can add support with additional hardware (not included):

1. Using the four holes in the *Adjustment Bracket* as a template, drill four holes into the *Dish Reflector* with a 4.4 mm or 11/64" drill bit.
2. Secure the *Dish Reflector* to the *Adjustment Bracket* using M4 screws, washers, and nuts (not included).



640-00272-07

4. View the *Dish Reflector* from the front. Ensure that the three hooks (indicated below) of the *Rear Housing* are fully engaged with the inner wall of the *Dish Reflector* and locked into place.

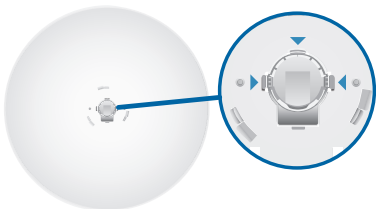

! **IMPORTANT:** Before proceeding, lightly pull the *Rear Housing* to confirm that it is locked into place.

5. Attach the *Antenna Feed*.
 - a. Insert the *Antenna Feed* into the *Rear Housing*, and push until it locks into place with a click.



- b. Lightly pull the *Antenna Feed* to ensure that it is locked into place and the *Release Button* is fully engaged.

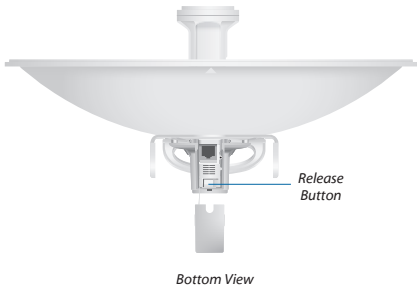

6. Connect an Ethernet cable to the *Ethernet Port* of the *Antenna Feed*. Then re-attach the *Cable Door* to the *Rear Housing*.



7. Attach the *Pole Clamp* to the *Mounting Bracket*.
- Hold the *Mounting Bracket* with its clamps facing you and the *Elevation Indicators* towards the top.
 - Insert the two *Long Carriage Bolts* through the holes of the *Mounting Bracket*.
 - Slide the hole of the *Pole Clamp* over one bolt of the *Mounting Bracket*.
 - Place one *Flange Nut* on each bolt.

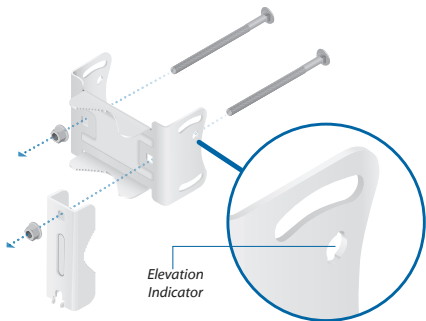

8. Mount the *Mounting Bracket* on the pole and secure it.
 - a. Place the *Mounting Bracket* against the pole.
 - b. Slide the slot of the *Pole Clamp* over the adjacent *Carriage Bolt*.
 - c. Tighten the *Flange Nuts* of the bolts to 25 N·m to secure the *Mounting Bracket* to the pole.

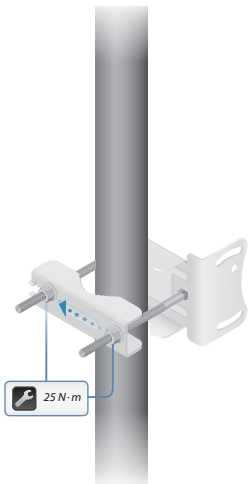

 **Note:** The mounting assembly can accommodate a $\text{Ø } 40 - 80 \text{ mm}$ pole.

9. Locate the two slots on the *Adjustment Bracket* and the two pivot pins on the *Mounting Bracket*. Place the *Reflector Dish* with the attached *Mounting Bracket* onto the pivot pins, ensuring that they fit securely inside of the slots.

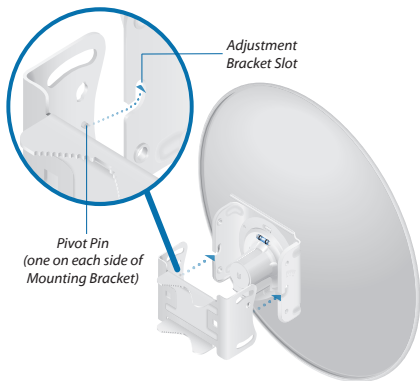

10. Install the four *Hex Bolts with Washers* into the *Mounting Bracket*. Do not tighten the four *Hex Bolts* completely.

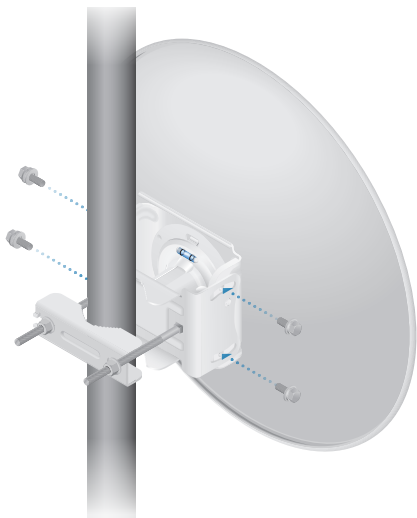

11. Adjust the elevation angle.

- a. Pivot the antenna until the *Elevation Indicator* shows the desired elevation angle.
- b. Tighten the four *Hex Bolts* completely.

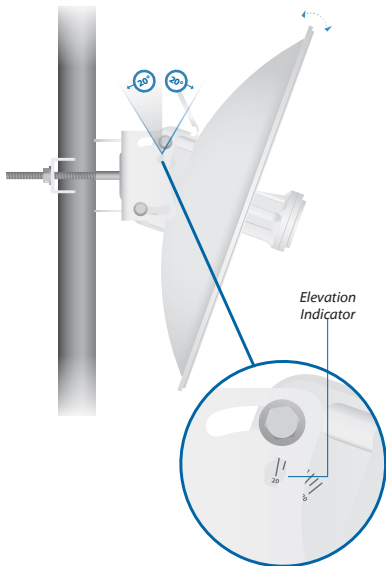

Connect the power using one of the following options:

- Using the included *Gigabit PoE Adapter*: Go to *Connecting to the PoE Adapter*.
- Using a separate PoE switch: Connect the Ethernet cable from the PowerBeam's *Ethernet* port to a PoE-enabled Ethernet port on the switch.

! **WARNING:** The switch port must comply with the power specifications listed in the *Specifications* section of this Quick Start Guide.

Connecting to the PoE Adapter

1. Connect the Ethernet cable from the PowerBeam's *Ethernet* port to the **POE** port of the *Gigabit PoE adapter*.
2. Connect an Ethernet cable from your LAN to the adapter's **LAN** port.
3. Connect the *Power Cord* to the adapter's power port. Connect the other end of the *Power Cord* to a power outlet.



Mounting the PoE Adapter (Optional)

1. Remove the *PoE Mounting Bracket* from the adapter, place the bracket at the desired location, and mark the two holes.
2. Pre-drill the holes if necessary, and secure the bracket using two fasteners (not included).
3. Align the adapter's slots with the tabs of the *PoE Mounting Bracket*, and then slide the adapter down.



Accessing airOS via Wi-Fi

Verify connectivity in the airOS Configuration Interface. There are two methods, the UNMS™ app and Web Portal. Both are available for 15 minutes immediately after you power on the PowerBeam. If necessary, you can power cycle the PowerBeam to re-enable its Wi-Fi.

Proceed to the appropriate instructions:

UNMS App

1. Download the UNMS app from the App Store (iOS) or Google Play™ (Android).



2. Connect your device's Wi-Fi to the PowerBeam SSID named: **PBE-5AC-Gen2:<MAC Address>**



Note: Ensure that DHCP is enabled on your Wi-Fi adapter.

3. Launch the app.
4. Tap the PowerBeam on the *Connections* screen.

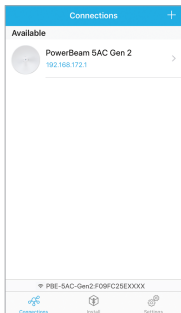

5. Tap **Connect** on the *Login* screen.

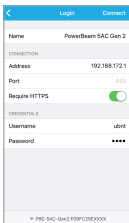

6. Select your *Country* and tap **Done**.

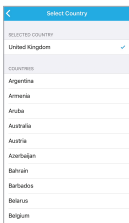

7. Customize your settings as needed.



Web Portal

1. Connect your device's Wi-Fi to the PowerBeam SSID named: **PBE-5AC-Gen2:<MAC Address>**



Note: Ensure that your Wi-Fi connection has DHCP enabled.

2. Launch a web browser and go to: **http://setup.ubnt.com**



3. Enter **ubnt** in the *Username* and *Password* fields. Select your *Country* and *Language*. You must agree to the *Terms of Use* to use the product. Click **Login**.

PowerBeam 5AC Gen2

Login

Please login to manage your wireless device.

Username
ubnt

Password

Country
Select Your Country

Language
English

TERMS OF USE

The Ubiquiti Networks, Inc. sales dealer must be pre-authorized installed. Properly installed shielded Ethernet cables and earth grounding must be used in accordance of product warranty. It is the installer's responsibility to follow local country regulations including operation within legal frequency channels, output power, and Dynamic Frequency Selection (DFS) requirements. You are responsible for keeping the unit working according to these rules.
You must also read and agree to the terms of the UBIQUITI FIRMWARE LICENSE AGREEMENT in the link below before you can download or install or use the "Ubiquiti airOS" Firmware.

[UBIQUITI FIRMWARE LICENSE AGREEMENT](#)

I agree to these **TERMS OF USE** and the **UBIQUITI FIRMWARE LICENSE AGREEMENT**

LOGIN



Note: The *Country* setting for U.S. product versions is restricted to a choice of Canada, Puerto Rico, or the U.S. to ensure compliance with FCC/IC regulations.

The airOS Configuration Interface will appear, allowing you to customize your settings as needed. For additional details on the airOS Configuration Interface, refer to the User Guide available at www.ubnt.com/download/airmax

Installer Compliance Responsibility

Devices must be professionally installed and it is the professional installer's responsibility to make sure the device is operated within local country regulatory requirements.

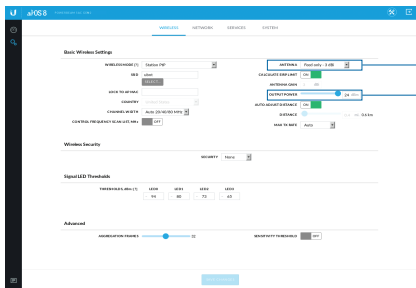

Since Ubiquiti Networks equipment can be paired with a variety of antennas and cables, the *Antenna* and *Output Power* fields are provided to the professional installer to assist in meeting regulatory requirements.

Specifications

PBE-5AC-Gen2	
Dimensions	420 x 420 x 230 mm (16.54 x 16.54 x 9.06")
Weight	2.22 kg (4.89 lb)
Gain	25 dBi
Networking Interface	(1) 10/100/1000 Ethernet Port
Processor	MIPS 74Kc
Enclosure Characteristics Antenna Feed Dish Reflector	Outdoor UV Stabilized Plastic Powder-Coated SPCC
Max. Power Consumption	8.5W
Max. TX Power	24 dBm
Power Supply	24V, 0.5A Gigabit PoE Adapter (Included)
Power Method	Passive PoE (Pairs 4, 5+; 7, 8 Return)
Supported Voltage Range	20 to 26VDC
Wind Loading	380 N @ 200 km/h (85.4 lbf @ 125 mph)
Wind Survivability	200 km/h (125 mph)
Mounting	Pole Mounting Kit Included
Operating Temperature	-40 to 70° C (-40 to 158° F)
Operating Humidity	5 to 95% Noncondensing
Shock and Vibrations	ETSI300-019-1.4
Certifications	CE, FCC, IC

Operating Frequency (MHz)				
Worldwide	5150 - 5875			
USA	U-NII-1: 5150 - 5250	U-NII-2A: 5250 - 5350	U-NII-2C: 5470 - 5725	U-NII-3: 5725 - 5850

Management Radio (MHz)	
Worldwide	2412 - 2472
USA	2412 - 2462

Safety Notices

1. Read, follow, and keep these instructions.
2. Heed all warnings.
3. Only use attachments/accessories specified by the manufacturer.



WARNING: Do not use this product in a location that can be submerged by water.



WARNING: Avoid using this product during an electrical storm. There may be a remote risk of electric shock from lightning.

Electrical Safety Information

1. Compliance is required with respect to voltage, frequency, and current requirements indicated on the manufacturer's label. Connection to a different power source than those specified may result in improper operation, damage to the equipment or pose a fire hazard if the limitations are not followed.
2. There are no operator serviceable parts inside this equipment. Service should be provided only by a qualified service technician.
3. This equipment is provided with a detachable power cord which has an integral safety ground wire intended for connection to a grounded safety outlet.
 - a. Do not substitute the power cord with one that is not the provided approved type. Never use an adapter plug to connect to a 2-wire outlet as this will defeat the continuity of the grounding wire.
 - b. The equipment requires the use of the ground wire as a part of the safety certification, modification or misuse can provide a shock hazard that can result in serious injury or death.
 - c. Contact a qualified electrician or the manufacturer if there are questions about the installation prior to connecting the equipment.
 - d. Protective earthing is provided by Listed AC adapter. Building installation shall provide appropriate short-circuit backup protection.
 - e. Protective bonding must be installed in accordance with local national wiring rules and regulations.

Limited Warranty

UBIQUITI NETWORKS, Inc (“UBIQUITI NETWORKS”) warrants that the product(s) furnished hereunder (the “Product(s)”) shall be free from defects in material and workmanship for a period of one (1) year from the date of shipment by UBIQUITI NETWORKS under normal use and operation. UBIQUITI NETWORKS’ sole and exclusive obligation and liability under the foregoing warranty shall be for UBIQUITI NETWORKS, at its discretion, to repair or replace any Product that fails to conform to the above warranty during the above warranty period. The expense of removal and reinstallation of any Product is not included in this warranty. The warranty period of any repaired or replaced Product shall not extend beyond its original term.

Warranty Conditions

The above warranty does not apply if the Product:

- (I) has been modified and/or altered, or an addition made thereto, except by Ubiquiti Networks, or Ubiquiti Networks’ authorized representatives, or as approved by Ubiquiti Networks in writing;
- (II) has been painted, rebranded or physically modified in any way;
- (III) has been damaged due to errors or defects in cabling;
- (IV) has been subjected to misuse, abuse, negligence, abnormal physical, electromagnetic or electrical stress, including lightning strikes, or accident;
- (V) has been damaged or impaired as a result of using third party firmware;
- (VI) has no original Ubiquiti MAC label, or is missing any other original Ubiquiti label(s); or
- (VII) has not been received by Ubiquiti within 30 days of issuance of the RMA.

In addition, the above warranty shall apply only if: the product has been properly installed and used at all times in accordance, and in all material respects, with the applicable Product documentation; all Ethernet cabling runs use CAT5 (or above), and for outdoor installations, shielded Ethernet cabling is used, and for indoor installations, indoor cabling requirements are followed.

Returns

No Products will be accepted for replacement or repair without obtaining a Return Materials Authorization (RMA) number from UBIQUITI NETWORKS during the warranty period, and the Products being received at UBIQUITI NETWORKS’ facility freight prepaid in accordance with the RMA process of UBIQUITI NETWORKS. Products returned without an RMA number will not be processed and will be returned freight collect or subject to disposal. Information on the RMA process and obtaining an RMA number can be found at: www.ubnt.com/support/warranty

Disclaimer

EXCEPT FOR ANY EXPRESS WARRANTIES PROVIDED HEREIN, UBIQUITI NETWORKS, ITS AFFILIATES, AND ITS AND THEIR THIRD PARTY DATA, SERVICE, SOFTWARE AND HARDWARE PROVIDERS HEREBY DISCLAIM AND MAKE NO OTHER REPRESENTATION OR WARRANTY OF ANY KIND, EXPRESS, IMPLIED OR STATUTORY, INCLUDING, BUT NOT LIMITED TO, REPRESENTATIONS, GUARANTEES, OR WARRANTIES OF MERCHANTABILITY, ACCURACY, QUALITY OF SERVICE OR RESULTS, AVAILABILITY, SATISFACTORY QUALITY, LACK OF VIRUSES, QUIET ENJOYMENT, FITNESS FOR A PARTICULAR PURPOSE AND NON-INFRINGEMENT AND ANY WARRANTIES ARISING FROM ANY COURSE OF DEALING, USAGE OR TRADE PRACTICE IN CONNECTION WITH SUCH PRODUCTS AND SERVICES. BUYER ACKNOWLEDGES THAT NEITHER UBIQUITI NETWORKS NOR ITS THIRD PARTY PROVIDERS CONTROL BUYER'S EQUIPMENT OR THE TRANSFER OF DATA OVER COMMUNICATIONS FACILITIES, INCLUDING THE INTERNET, AND THAT THE PRODUCTS AND SERVICES MAY BE SUBJECT TO LIMITATIONS, INTERRUPTIONS, DELAYS, CANCELLATIONS AND OTHER PROBLEMS INHERENT IN THE USE OF COMMUNICATIONS FACILITIES. UBIQUITI NETWORKS, ITS AFFILIATES AND ITS AND THEIR THIRD PARTY PROVIDERS ARE NOT RESPONSIBLE FOR ANY INTERRUPTIONS, DELAYS, CANCELLATIONS, DELIVERY FAILURES, DATA LOSS, CONTENT CORRUPTION, PACKET LOSS, OR OTHER DAMAGE RESULTING FROM ANY OF THE FOREGOING. In addition, UBIQUITI NETWORKS does not warrant that the operation of the Products will be error-free or that operation will be uninterrupted. In no event shall UBIQUITI NETWORKS be responsible for damages or claims of any nature or description relating to system performance, including coverage, buyer's selection of products (including the Products) for buyer's application and/or failure of products (including the Products) to meet government or regulatory requirements.

Limitation of Liability

EXCEPT TO THE EXTENT PROHIBITED BY LOCAL LAW, IN NO EVENT WILL UBIQUITI OR ITS SUBSIDIARIES, AFFILIATES OR SUPPLIERS BE LIABLE FOR DIRECT, SPECIAL, INCIDENTAL, CONSEQUENTIAL OR OTHER DAMAGES (INCLUDING LOST PROFIT, LOST DATA, OR DOWNTIME COSTS), ARISING OUT OF THE USE, INABILITY TO USE, OR THE RESULTS OF USE OF THE PRODUCT, WHETHER BASED IN WARRANTY, CONTRACT, TORT OR OTHER LEGAL THEORY, AND WHETHER OR NOT ADVISED OF THE POSSIBILITY OF SUCH DAMAGES.

Note

Some countries, states and provinces do not allow exclusions of implied warranties or conditions, so the above exclusion may not apply to you. You may have other rights that vary from country to country, state to state, or province to province. Some countries, states and provinces do not allow the exclusion or limitation of liability for incidental or consequential damages, so the above limitation may not apply to you. EXCEPT TO THE EXTENT ALLOWED BY LOCAL LAW, THESE WARRANTY TERMS DO NOT EXCLUDE, RESTRICT OR MODIFY, AND ARE IN ADDITION TO, THE MANDATORY STATUTORY RIGHTS APPLICABLE TO THE LICENSE OF ANY SOFTWARE (EMBEDDED IN THE PRODUCT) TO YOU. The United Nations Convention on Contracts for the International Sale of Goods shall not apply to any transactions regarding the sale of the Products.

Compliance

FCC

Changes or modifications not expressly approved by the party responsible for compliance could void the user's authority to operate the equipment.

This device complies with Part 15 of the FCC Rules. Operation is subject to the following two conditions.

1. This device may not cause harmful interference, and
2. This device must accept any interference received, including interference that may cause undesired operation.

This equipment has been tested and found to comply with the limits for a Class A digital device, pursuant to Part 15 of the FCC Rules. These limits are designed to provide reasonable protection against harmful interference when the equipment is operated in a commercial environment. This equipment generates, uses, and can radiate radio frequency energy and, if not installed and used in accordance with the instruction manual, may cause harmful interference to radio communications. Operations of this equipment in a residential area is likely to cause harmful interference in which case the user will be required to correct the interference at his own expense.

This radio transmitter (FCC ID: SWX-PBE5ACG2) has been approved by FCC to operate with the antenna types listed below with the maximum permissible gain and required antenna impedance for each antenna type indicated. Antenna types not included in this list, having a gain greater than the maximum gain indicated for that type, are strictly prohibited for use with this device.

Antenna Information: Dish antenna, Gain: 25 dBi

ISED Canada

CAN ICES-3(A)/NMB-3(A)

This device complies with ISED Canada licence-exempt RSS standard(s). Operation is subject to the following two conditions:

1. This device may not cause interference, and
2. This device must accept any interference, including interference that may cause undesired operation of the device.

This radio transmitter (IC: 6545A-PBE5ACG2) has been approved by ISED Canada to operate with the antenna types listed below with the maximum permissible gain and required antenna impedance for each antenna type indicated. Antenna types not included in this list, having a gain greater than the maximum gain indicated for that type, are strictly prohibited for use with this device.

Antenna Information: Dish antenna, Gain: 25 dBi

CAN ICES-3(A)/NMB-3(A)

Le présent appareil est conforme aux CNR d'ISDE Canada applicables aux appareils radio exempts de licence. L'exploitation est autorisée aux deux conditions suivantes :

1. l'appareil ne doit pas produire de brouillage;
2. l'appareil doit accepter tout brouillage radioélectrique subi, même si le brouillage est susceptible d'en compromettre le fonctionnement.

Le présent émetteur radio (IC: 6545A-PBE5ACG2) a été approuvé par ISDE Canada pour l'exploitation avec l'antenne types énumérés ci-dessous avec le gain maximal admissible et requis l'impédance de l'antenne pour chaque type d'antenne indiqué. Types d'antenne non inclus dans cette liste, ayant un gain supérieur au gain maximal indiqué pour ce type, sont strictement interdits pour une utilisation avec cet appareil.

Informations d'antenne: Antenne parabolique, Gain: 25 dBi

RF Exposure Warning

The antennas used for this transmitter must be installed to provide a separation distance of at least 20 cm from all persons and must not be located or operating in conjunction with any other antenna or transmitter.

Les antennes utilisées pour ce transmetteur doivent être installé en considérant une distance de séparation de toute personnes d'au moins 20 cm et ne doivent pas être localisé ou utilisé en conflit avec tout autre antenne ou transmetteur.

Australia and New Zealand



Warning: This is a Class A product. In a domestic environment this product may cause radio interference in which case the user may be required to take adequate measures.

CE Marking

CE marking on this product represents the product is in compliance with all directives that are applicable to it.

CE

Country List



AT	BE	BG	CY	CZ	DE	DK	EE	EL	ES	FI	FR	HR	HU
IE	IT	LV	LT	LU	MT	NL	PL	PT	RO	SE	SI	SK	UK

BFWA (Broadband Fixed Wireless Access) members noted in blue



Note: This device meets Max. TX power limit per ETSI regulations.

The following apply to products that operate in the 5 GHz frequency range:



Note: This device is restricted to indoor use only when operating in the 5150 - 5350 MHz frequency range within all member states.



Note: All countries listed may operate at 30 dBm. BFWA member states may operate at 36 dBm.



Note: Operation in the 5.8 GHz frequency band is prohibited in BFWA member states. Other countries listed may use the 5.8 GHz frequency band.

RoHS/WEEE Compliance Statement



English

European Directive 2012/19/EU requires that the equipment bearing this symbol on the product and/or its packaging must not be disposed of with unsorted municipal waste. The symbol indicates that this product should be disposed of separately from regular household waste streams. It is your responsibility to dispose of this and other electric and electronic equipment via designated collection facilities appointed by the government or local authorities. Correct disposal and recycling will help prevent potential negative consequences to the environment and human health. For more detailed information about the disposal of your old equipment, please contact your local authorities, waste disposal service, or the shop where you purchased the product.

Deutsch

Die Europäische Richtlinie 2012/19/EU verlangt, dass technische Ausrüstung, die direkt am Gerät und/oder an der Verpackung mit diesem Symbol versehen ist, nicht zusammen mit unsortiertem Gemeindeabfall entsorgt werden darf. Das Symbol weist darauf hin, dass das Produkt von regulärem Haushaltsmüll getrennt entsorgt werden sollte. Es liegt in Ihrer Verantwortung, dieses Gerät und andere elektrische und elektronische Geräte über die dafür zuständigen und von der Regierung oder örtlichen Behörden dazu bestimmten Sammelstellen zu entsorgen. Ordnungsgemäßes Entsorgen und Recyceln trägt dazu bei, potentielle negative Folgen für Umwelt und die menschliche Gesundheit zu vermeiden. Wenn Sie weitere Informationen zur Entsorgung Ihrer Altgeräte benötigen, wenden Sie sich bitte an die örtlichen Behörden oder städtischen Entsorgungsdienste oder an den Händler, bei dem Sie das Produkt erworben haben.

Español

La Directiva 2012/19/UE exige que los equipos que lleven este símbolo en el propio aparato y/o en su embalaje no deben eliminarse junto con otros residuos urbanos no seleccionados. El símbolo indica que el producto en cuestión debe separarse de los residuos domésticos convencionales con vistas a su eliminación. Es responsabilidad suya desechar este y cualesquiera otros aparatos eléctricos y electrónicos a través de los puntos de recogida que ponen a su disposición el gobierno y las autoridades locales. Al desechar y reciclar correctamente estos aparatos estará contribuyendo a evitar posibles consecuencias negativas para el medio ambiente y la salud de las personas. Si desea obtener información más detallada sobre la eliminación segura de su aparato usado, consulte a las autoridades locales, al servicio de recogida y eliminación de residuos de su zona o pregunte en la tienda donde adquirió el producto.

Français

La directive européenne 2012/19/UE exige que l'équipement sur lequel est apposé ce symbole sur le produit et/ou son emballage ne soit pas jeté avec les autres ordures ménagères. Ce symbole indique que le produit doit être éliminé dans un circuit distinct de celui pour les déchets des ménages. Il est de votre responsabilité de jeter ce matériel ainsi que tout autre matériel électrique ou électronique par les moyens de collecte indiqués par le gouvernement et les pouvoirs publics des collectivités territoriales. L'élimination et le recyclage en bonne et due forme ont pour but de lutter contre l'impact néfaste potentiel de ce type de produits sur l'environnement et la santé publique. Pour plus d'informations sur le mode d'élimination de votre ancien équipement, veuillez prendre contact avec les pouvoirs publics locaux, le service de traitement des déchets, ou l'endroit où vous avez acheté le produit.

Italiano

La direttiva europea 2012/19/UE richiede che le apparecchiature contrassegnate con questo simbolo sul prodotto e/o sull'imballaggio non siano smaltite insieme ai rifiuti urbani non differenziati. Il simbolo indica che questo prodotto non deve essere smaltito insieme ai normali rifiuti domestici. È responsabilità del proprietario smaltire sia questi prodotti sia le altre apparecchiature elettriche ed elettroniche mediante le specifiche strutture di raccolta indicate dal governo o dagli enti pubblici locali. Il corretto smaltimento ed il riciclaggio aiuteranno a prevenire conseguenze potenzialmente negative per l'ambiente e per la salute dell'essere umano. Per ricevere informazioni più dettagliate circa lo smaltimento delle vecchie apparecchiature in Vostro possesso, Vi invitiamo a contattare gli enti pubblici di competenza, il servizio di smaltimento rifiuti o il negozio nel quale avete acquistato il prodotto.

Declaration of Conformity

български [Bulgarian] С настоящото UBIQUITI NETWORKS декларира, че този тип радиосъоръжение PBE-5AC-Gen2 е в съответствие с Директива 2014/53/ЕС. Цялостният текст на ЕС декларацията за съответствие може да се намери на следния интернет адрес: www.ubnt.com/compliance

Hrvatski [Croatian] UBIQUITI NETWORKS ovime izjavljuje da je radijska oprema tipa PBE-5AC-Gen2 u skladu s Direktivom 2014/53/EU. Cjeloviti tekst EU izjave o sukladnosti dostupan je na sljedećoj internetskoj adresi: www.ubnt.com/compliance

Čeština [Czech] Tímto UBIQUITI NETWORKS prohlašuje, že typ rádiového zařízení PBE-5AC-Gen2 je v souladu se směrnicí 2014/53/EU. Úplné znění EU prohlášení o shodě je k dispozici na této internetové adrese: www.ubnt.com/compliance

Dansk [Danish] Hermed erklærer UBIQUITI NETWORKS, at radioudstyrstypen PBE-5AC-Gen2 er i overensstemmelse med direktiv 2014/53/EU. EU-overensstemmelseserklæringens fulde tekst kan findes på følgende internetadresse: www.ubnt.com/compliance

Nederlands [Dutch] Hierbij verklaar ik, UBIQUITI NETWORKS, dat het type radioapparatuur PBE-5AC-Gen2 conform is met Richtlijn 2014/53/EU. De volledige tekst van de EU-conformiteitsverklaring kan worden geraadpleegd op het volgende internetadres: www.ubnt.com/compliance

English Hereby, UBIQUITI NETWORKS declares that the radio equipment type PBE-5AC-Gen2 is in compliance with Directive 2014/53/EU. The full text of the EU declaration of conformity is available at the following internet address: www.ubnt.com/compliance

Eesti keel [Estonian] Käesolevaga deklareerib UBIQUITI NETWORKS, et käesolev raadioseadme tüüp PBE-5AC-Gen2 vastab direktiivi 2014/53/EL nõuetele. ELi vastavusdeklaratsiooni täielik tekst on kättesaadav järgmisel internetiaadressil: www.ubnt.com/compliance

Suomi [Finnish] UBIQUITI NETWORKS vakuuttaa, että radiolaitetyypin PBE-5AC-Gen2 on direktiivin 2014/53/EU mukainen. EU-vaatimustenmukaisuusvakuutuksen täysimittainen teksti on saatavilla seuraavassa internetosoitteessa: www.ubnt.com/compliance

Français [French] Le soussigné, UBIQUITI NETWORKS, déclare que l'équipement radioélectrique du type PBE-5AC-Gen2 est conforme à la directive 2014/53/UE. Le texte complet de la déclaration UE de conformité est disponible à l'adresse internet suivante: www.ubnt.com/compliance

Deutsch [German] Hiermit erkläre UBIQUITI NETWORKS, dass der Funkanlagentyp PBE-5AC-Gen2 der Richtlinie 2014/53/EU entspricht. Der vollständige Text der EU-Konformitätserklärung ist unter der folgenden Internetadresse verfügbar: www.ubnt.com/compliance

Ελληνικά [Greek] Με την παρούσα ο/η UBIQUITI NETWORKS, δηλώνει ότι ο ραδιοεξοπλισμός PBE-5AC-Gen2 πληροί την οδηγία 2014/53/ΕΕ. Το πλήρες κείμενο της δήλωσης συμμόρφωσης ΕΕ διατίθεται στην ακόλουθη ιστοσελίδα στο διαδίκτυο: www.ubnt.com/compliance

Magyar [Hungarian] UBIQUITI NETWORKS igazolja, hogy a PBE-5AC-Gen2 típusú rádióberendezés megfelel a 2014/53/EU irányelvnek. Az EU-megfelelőségi nyilatkozat teljes szövege elérhető a következő internetes címen: www.ubnt.com/compliance

Íslenska [Icelandic] Hér með lýsir UBIQUITI NETWORKS yfir því að PBE-5AC-Gen2 er í samræmi við grunnkröfur og aðrar kröfur, sem gerðar eru í tilskipun 2014/53/EU. Fullur texti ESB samræmisýrflýsing er að finna á eftirfarandi netfangi: www.ubnt.com/compliance

Italiano [Italian] Il fabbricante, UBIQUITI NETWORKS, dichiara che il tipo di apparecchiatura radio PBE-5AC-Gen2 è conforme alla direttiva 2014/53/UE. Il testo completo della dichiarazione di conformità UE è disponibile al seguente indirizzo Internet: www.ubnt.com/compliance

Latviešu valoda [Latvian] Ar šo UBIQUITI NETWORKS deklarē, ka radioiekārta PBE-5AC-Gen2 atbilst Direktīvai 2014/53/ES. Pilns ES atbilstības deklarācijas teksts ir pieejams šādā interneta vietnē: www.ubnt.com/compliance

Lietuvių kalba [Lithuanian] Aš, UBIQUITI NETWORKS, patvirtinu, kad radijo įrenginių tipas PBE-5AC-Gen2 atitinka Direktyvą 2014/53/ES. Visas ES atitikties deklaracijos tekstas prieinamas šiuo interneto adresu: www.ubnt.com/compliance

Malti [Maltese] B'dan, UBIQUITI NETWORKS, niddikjara li dan it-tip ta' tagħmir tar-radju PBE-5AC-Gen2 huwa konformi mad-Direttiva 2014/53/UE. Id-dikjarazzjoni tal-konformità tista' tiġi kkonsultata minn www.ubnt.com/compliance

Norsk [Norwegian] UBIQUITI NETWORKS erklærer herved at utstyret PBE-5AC-Gen2 er i samsvar med de grunnleggende krav og øvrige relevante krav i direktiv 2014/53/EU. Den fulle teksten til EU-samsvarserklæringen er tilgjengelig på følgende internettadresse: www.ubnt.com/compliance

Polski [Polish] UBIQUITI NETWORKS niniejszym oświadczam, że typ urządzenia radiowego PBE-5AC-Gen2 jest zgodny z dyrektywą 2014/53/UE. Pełny tekst deklaracji zgodności UE jest dostępny pod następującym adresem internetowym: www.ubnt.com/compliance

Português [Portuguese] O(a) abaixo assinado(a) UBIQUITI NETWORKS declara que o presente tipo de equipamento de rádio PBE-5AC-Gen2 está em conformidade com a Diretiva 2014/53/UE. O texto integral da declaração de conformidade está disponível no seguinte endereço de Internet: www.ubnt.com/compliance

Română [Romanian] Prin prezenta, UBIQUITI NETWORKS declară că tipul de echipament radio PBE-5AC-Gen2 este în conformitate cu Directiva 2014/53/UE. Textul integral al declarației UE de conformitate este disponibil la următoarea adresă internet: www.ubnt.com/compliance

Slovenčina [Slovak] UBIQUITI NETWORKS týmto vyhlasuje, že rádiové zariadenie typu PBE-5AC-Gen2 je v súlade so smernicou 2014/53/EÚ. Úplné EÚ vyhlásenie o zhode je k dispozícii na tejto internetovej adrese: www.ubnt.com/compliance

Slovenščina [Slovenian] UBIQUITI NETWORKS potrjuje, da je tip radijske opreme PBE-5AC-Gen2 skladen z Direktivo 2014/53/EU. Celotno besedilo izjave EU o skladnosti je na voljo na naslednjem spletnem naslovu: www.ubnt.com/compliance

Español [Spanish] Por la presente, UBIQUITI NETWORKS declara que el tipo de equipo radioeléctrico PBE-5AC-Gen2 es conforme con la Directiva 2014/53/UE. El texto completo de la declaración UE de conformidad está disponible en la dirección Internet siguiente: www.ubnt.com/compliance

Svenska [Swedish] Härmed försäkras UBIQUITI NETWORKS att denna typ av radioutrustning PBE-5AC-Gen2 överensstämmer med direktiv 2014/53/EU. Den fullständiga texten till EU-försäkran om överensstämmelse finns på följande webbadress: www.ubnt.com/compliance

Online Resources

Support help.ubnt.com

Community community.ubnt.com

Downloads downloads.ubnt.com



www.ubnt.com

Ubiquiti Networks, Inc.
685 Third Avenue, 27th Floor
New York, NY 10017
USA